

*SBAVATURA
FINITURA
SUPERFINITURA*



TECNIMETAL

Via degli Andreani, 9 - 40037 Sasso Marconi (BO)

Tel: 051 735744 - Fax: 051 735808

www.tecnimetal-tm.com - E-mail: info@tecnimetal-tm.com

Stick ceramici abrasivi



MISURA	VERDE #150	ROSA #200	VIOLA #400	ARANCIO #600	BLU #800	BIANCO #1000
	40µm	36µm	30µm	20µm	15µm	10µm
1x2x100	JR150-0102100	JR200-0102100	JR400-0102100	JR600-0102100	JR800-0102100	JR1000-0102100
1x4x100	JR150-0104100	JR200-0104100	JR400-0104100	JR600-0104100	JR800-0104100	JR1000-0104100
1x6x100	JR150-0106100	JR200-0106100	JR400-0106100	JR600-0106100	JR800-0106100	JR1000-0106100
1x10x100	JR150-0110100	JR200-0110100	JR400-0110100	JR600-0110100	JR800-0110100	JR1000-0110100
1x13x100	JR150-0113100	JR200-0113100	JR400-0113100	JR600-0113100	JR800-0113100	JR1000-0113100
Ø3x50*	JR150-030050	JR200-030050	JR400-030050	JR600-030050	JR800-030050	JR1000-030050
Ø3x100	JR150-0300100	JR200-0300100	JR400-0300100	JR600-0300100	JR800-0300100	JR1000-0300100
Ø2.35x50*	JR150-023550	JR200-023550	JR400-023550	JR600-023550	JR800-023550	JR1000-023550
Ø2.35x100*	JR150-0235100	JR200-0235100	JR400-0235100	JR600-0235100	JR800-0235100	JR1000-0235100
SERIE MINI						
0.3x0.3x100*	JR150-0303100	JR200-0303100	JR400-0303100	JR600-0303100	JR800-0303100	JR1000-0303100
0.5x0.5x100*	JR150-0505100	JR200-0505100	JR400-0505100	JR600-0505100	JR800-0505100	JR1000-0505100
0.7x0.7x100*	JR150-0707100	JR200-0707100	JR400-0707100	JR600-0707100	JR800-0707100	JR1000-0707100
0.9x0.9x100*	JR150-0909100	JR200-0909100	JR400-0909100	JR600-0909100	JR800-0909100	JR1000-0909100
DIAMANTE						
	NERO #200	GRIGIO #400	VERDE SCURO #600	VERDE #800		
1x2x100	CSDI2-1002	CSDI4-1002	CSDI6-1002	CSDI8-1002		
1x4x100	CSD2-1004	CSD4-1004	CSD6-1004	CSD8-1004		
1x6x100	CSD2-1006	CSD4-1006	CSD6-1006	CSD8-1006		
1x10x100	CSD2-1010	CSD4-1010	CSD6-1010	CSD8-1010		
Ø3x100	CGDI2-3	CGDI4-3	CGDI6-3	CGDI8-3		

*a richiesta, ordine minimo 50pz

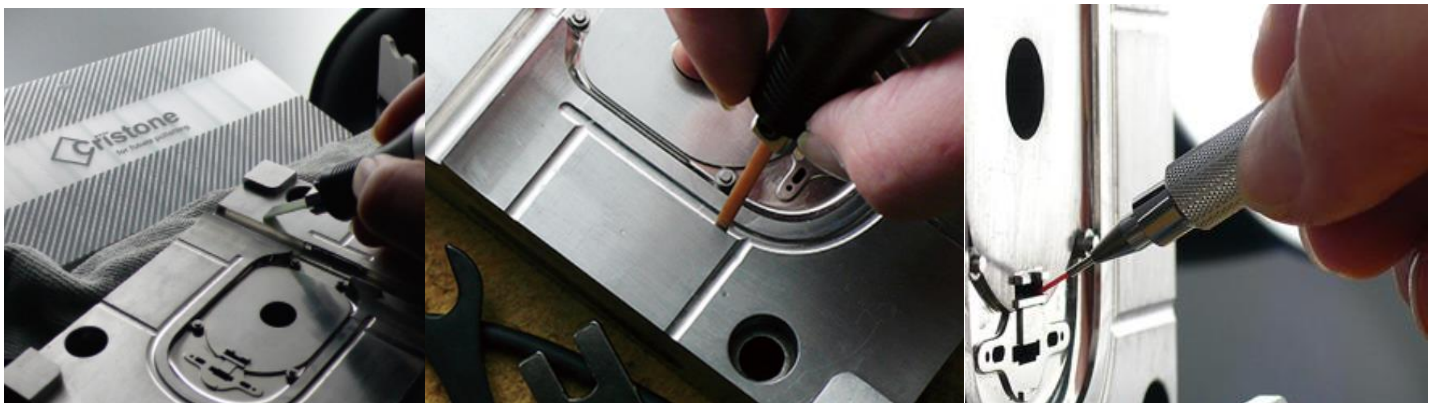

Stick ceramici abrasivi Ceraton



MISURA	CAFFE' #180 ●	ARANCIO #250 ●	GRIGIO #320 ●	BLU #400 ●	GIALLO #700 ●	BIANCO #1000 ○	ROSSO #1200 ●
1x4x100	BSC-1004	BSO-1004	BSG-1004	BSB-1004	BSY-1004	BSW-1004	BSR-1004
1x6x100	BSC-1006	BSO-1006	BSG-1006	BSB-1006	BSY-1006	BSW-1006	BSR-1006
1x10x100	BSC-1010	BSO-1010	BSG-1010	BSB-1010	BSY-1010	BSW-1010	BSR-1010
Ø3x100	BSC-30	BSO-30	BSG-30	BSB-30	BSY-30	BSW-30	BSR-30
SERIE MINI		#250		#400	#700		#1200
0.5x0.5x50		MOS-055		MBS-055	MYS-055		MRS-055
0.7x0.7x50		MOS-075		MBS-075	MYS-075		MRS-075
0.9x0.9x50		MOS-095		MBS-095	MYS-095		MRS-095
1.0x1.0x100		MOS-121		MBS-121	MYS-121		MRS-121
Ø0.9x50		MOS-105		MBS-105	MYS-105		MRS-105
Ø0.9x100		MOS-201		MBS-201	MYS-201		MRS-201
DIAMANTE	#200			#400	#600	#800	
1x4x100	SDS-1042			SDS-1044	SDS-1046	SDS-1048	
1x6x100	SDS-1062			SDS-1064	SDS-1066	SDS-1068	
1x10x100	SDS-1102			SDS-1104	SDS-1106	SDS-1106	
Ø3x100	SDS-302			SDS-304	SDS-306	SDS-308	

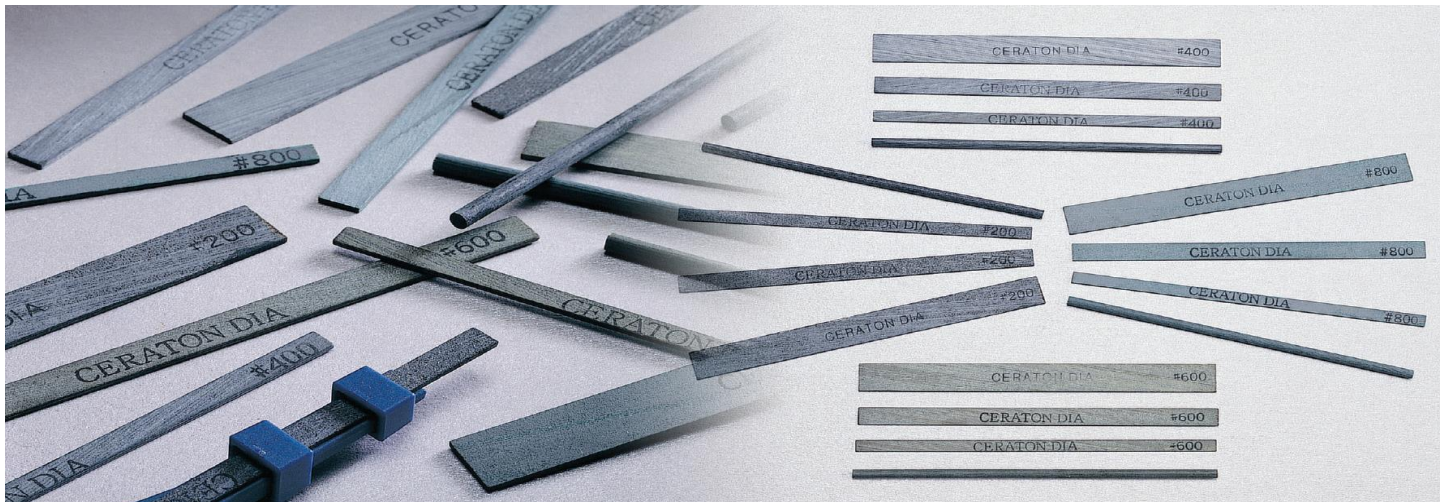

SUPPORTI PER STICK CERAMICI E PIETRE



XH-041
Stick Ceramici 4x1



XH-005
Stick Ceramici quadrati 0.3x0.3 o Tondi d.0.5



XH-061
Stick Ceramici 6x1



XH-007
Stick Ceramici quadrati 0.5x0.5 o Tondi d.0.7



XH-101
Stick Ceramici 10x1



XH-009
Stick Ceramici quadrati 0.7x0.7 o Tondi d.0.9



XH-062
Pietre 6x2 – 6x3



XH-200
Stick Ceramici Piatti 2x1 o tondi d.2.0



XH-133
Pietre 13x3



XH-013
Stick Ceramici quadrati 0.9x0.9 o Tondi d.1.3



XH-136
Pietre 13x6.3



XH-22
Stick Ceramici Tondi d.3.0

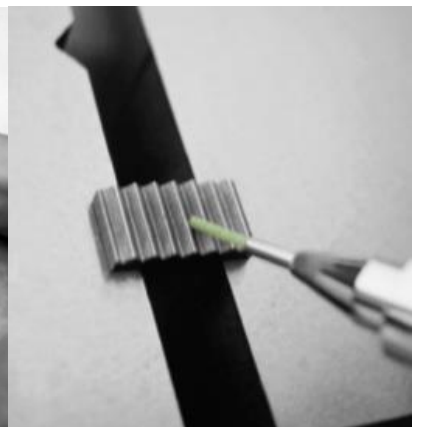

MOLETTE ROTATIVE

CORINDONE ROSA

Gambo d.3mm

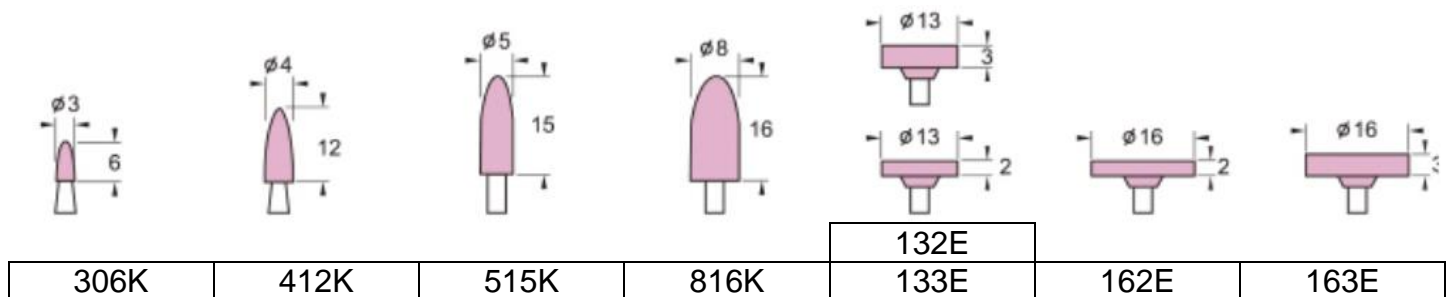
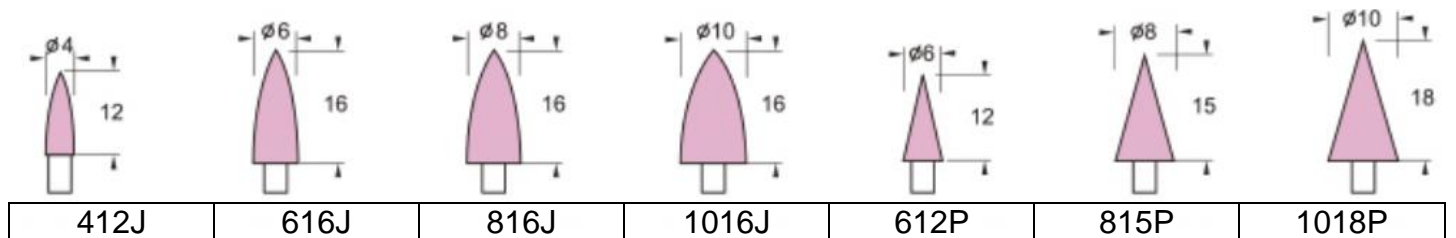
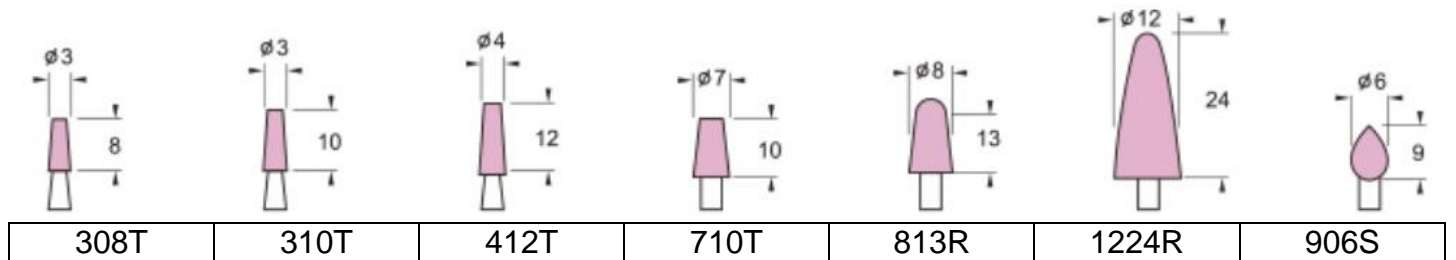
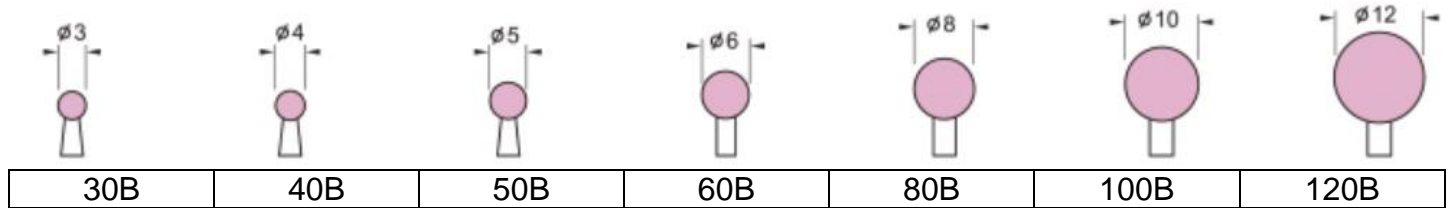
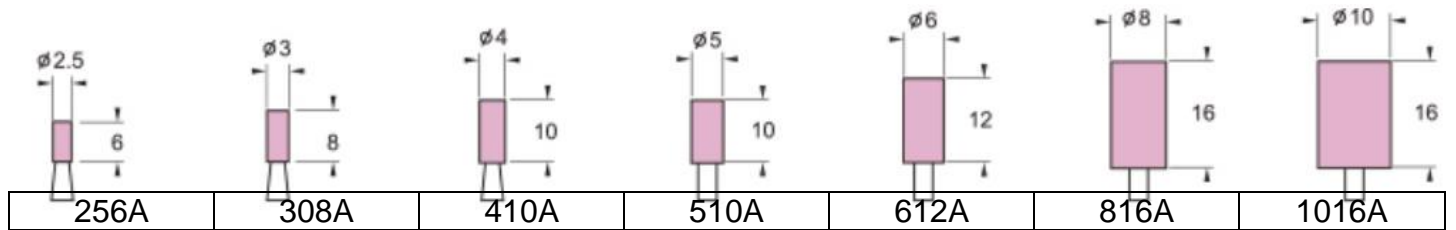

FELTRINI

Gambo d.3mm

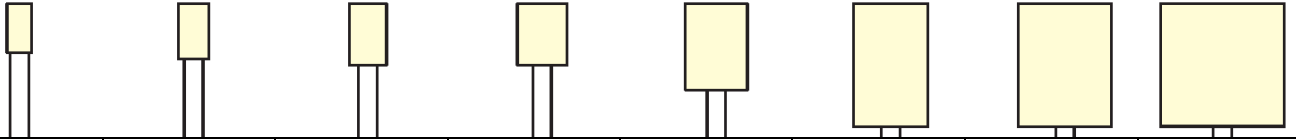
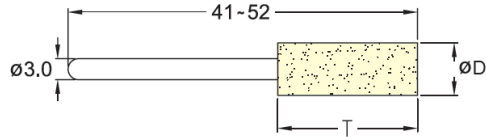

	AB-0408A	AB-0509A	AB-0610A	AB-0810A	AB-1014A	AB-1220A	AB-1520A	AB-2020A
\varnothing	4	5	6	8	10	12	15	20
T	8	9	10	10	14	20	20	20

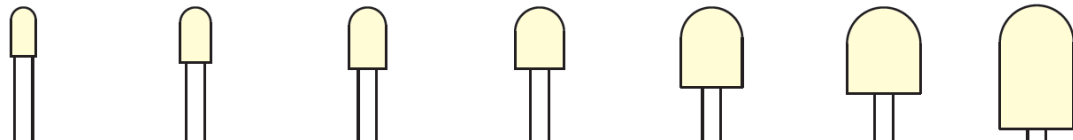

	AB-0408C	AB-0509C	AB-0610C	AB-0810C	AB-1013C	AB-1214C	AB-1220C
\varnothing	4	5	6	8	10	12	12
T	8	9	10	10	13	14	20

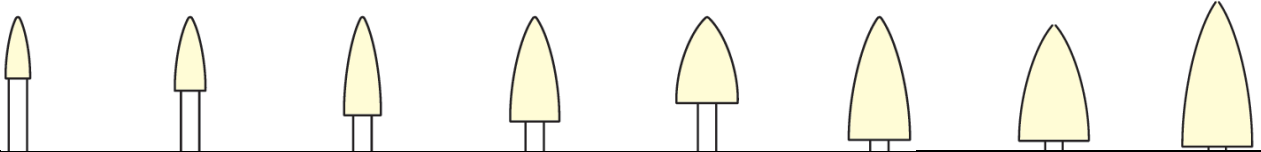

	AB-0410J	AB-0512J	AB-0616J	AB-0817J	AB-1014J	AB-1020J	AB-1220J	AB-1225J
\varnothing	4	5	6	8	10	20	20	25
T	10	12	16	17	14	20	20	25

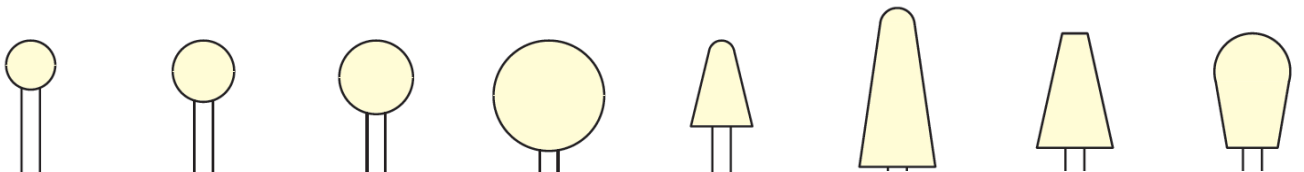

	AB-08B	AB-10B	AB-12B	AB-18B	AB-1014R	AB-1225R	AB-1218T	AB-1218H
\varnothing	8	10	12	18	10	12	12	12
T	8	10	12	18	14	25	18	18

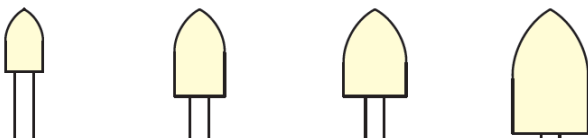

	AB-0610K	AB-0814K	AB-1014K	AB-1220K
\varnothing	6	8	10	12
T	10	14	14	20

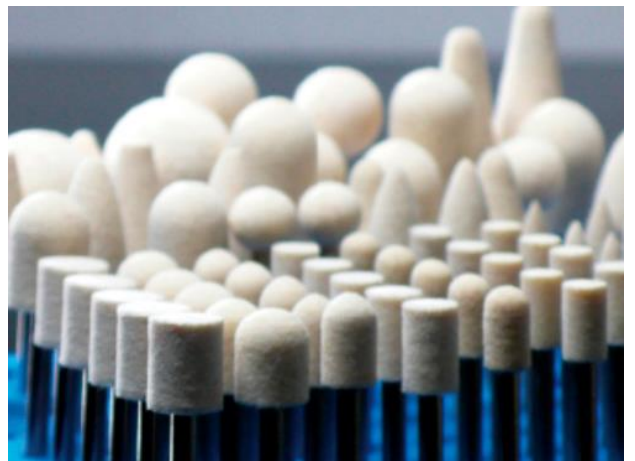

FELTRINI

Gambo d.6mm

Cod.	D. Ø	T	Forma
AC-1225A	12	25	
AC-1525A	15	25	
AC-2025A	20	25	
AC-2530A	25	30	
AC-1520C	15	20	
AC-2025C	20	25	
AC-2530C	25	30	
AC-3208E	32	8	
AC-4010E	40	9.6	
AC-1525K	15	25	
AC-2025K	20	25	
AC-2530K	25	30	

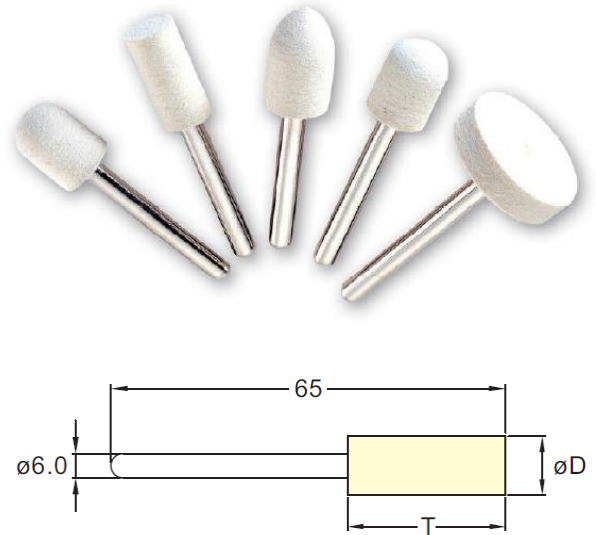

DISCHETTI FELTRO

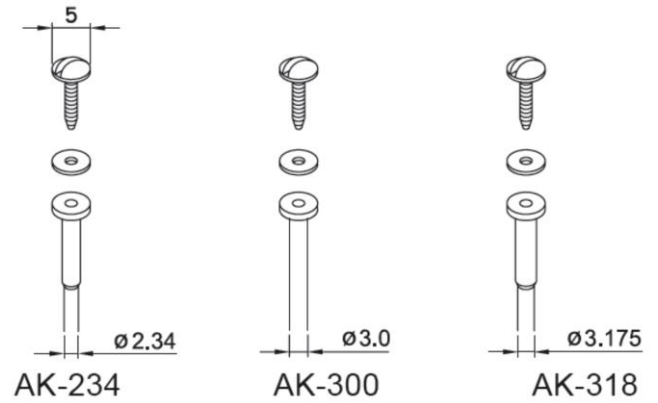
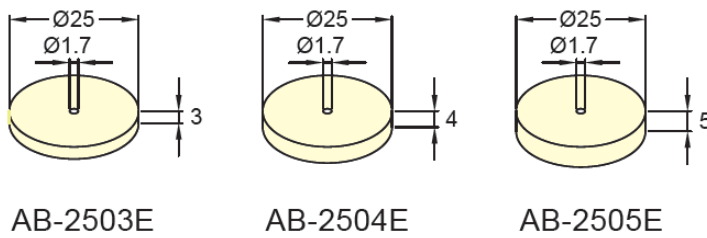

BASTONCINI FELTRO

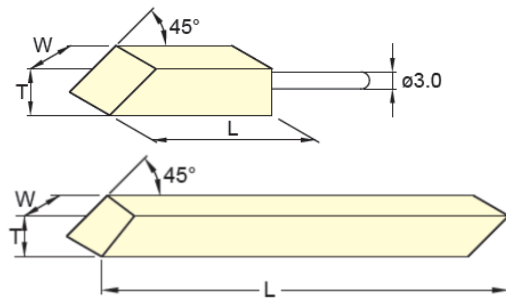

AB-R06	AB-R10	AB-R12
6 x 6 x 25	10 x 10 x 35	12 x 12 x 45

AB-S06	AB-S10
6 x 6 x 100 x 45°	10 x 10 x 100 x 45°

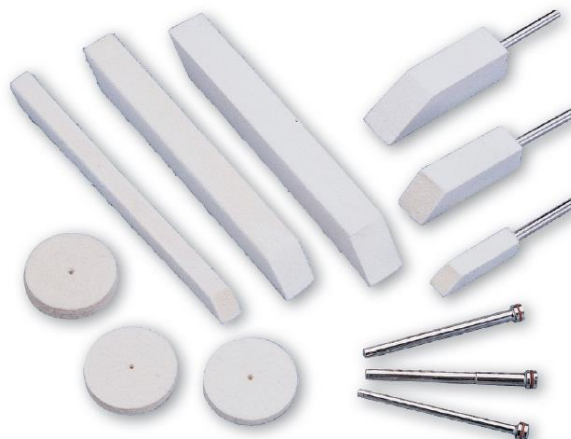

MOLETTE ROTATIVE & STICK DI LEGNO

VEICOLO PER PASTE ABRASIVE

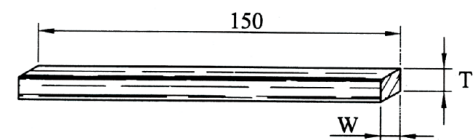
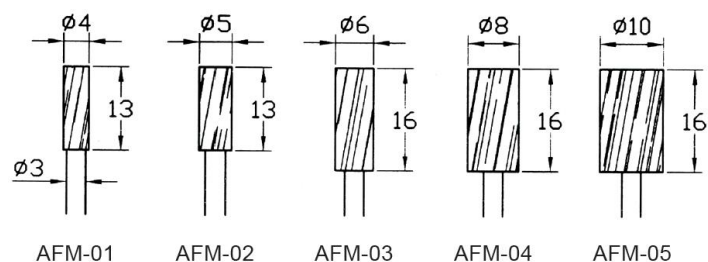

Order.no.	AFW-05H	AFW-06H	AFW-07H	AFW-08H
T x W	6.4 x 6.4	3.2 x 6.4	6.4 x 9.5	6.4 x 12.7

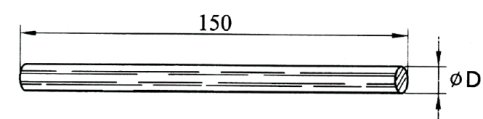

Order.no.	AFW-01H	AFW-02H	AFW-03H	AFW-04H
ØD	Ø3.2	Ø4.7	Ø6.4	Ø9.5



PIETRE DIAMANTATE

Pietre abrasive diamantate con legante resinoido, sono adatte sia all'affilatura di utensili che alla lucidatura di stampi. Disponibili in due modelli, con e senza impugnatura.

Profilo	Cod.	Dimensioni mm
	RSH-01	10x2x40
	RSH-02	5x2x40
	RSH-03	5x(2.5R)x4x40
	RSH-04	10x2x30
	RS-04	10x3x120
	RS-05	6x3x100
	RS-06	4x4x100
	RS-07	13x3x100
	RS-08	6x2x100

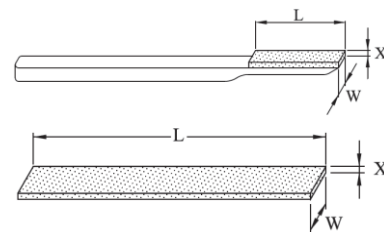

Grane: #100, #600, #200, #400, #600, #800, #1000, #1200, #1800, #2000, #3000, #5000, #8000

CARTA ABRASIVA & PANNI DIAMANTATI

FOGLI CARTA

Formato mm	Grana & Cod.								
	#120	#600	#200	#300	#400	#600	#800	#1200	#1800
10x100	XF-1012	XF-1015	XF-1020	XF-1030	XF-1040	XF-1060	XF-1080	XF-1120	XF-1180
50x100	XF-2012	XF-2015	XF-2020	XF-2030	XF-2040	XF-2060	XF-2080	XF-2120	XF-2180
100x100	XF-3012	XF-3015	XF-3020	XF-3030	XF-3040	XF-3060	XF-3080	XF-3120	XF-3180



PANNI

Grana Colore	Dimensione & Cod.			
	50x100mm	100x100mm	1170x295mm	690x295mm
#60	XZ-1006N	XZ-2006N	XZ-5006N	-
#120	XZ-1012N	XZ-2012N	XZ-5012N	-
#200	XZ-1020N	XZ-2020N	XZ-5020N	-
#400	XZ-1040N	XZ-2040N	XZ-5040N	-
#600	XZ-1060N	XZ-2060N	XZ-5060N	-
#800	XZ-1080R	XZ-2080R	-	XZ-6080R
#6000	XZ-1600R	XZ-2600R	-	XZ-6600R
#3000	XZ-1300R	XZ-2300R	-	XZ-6300R

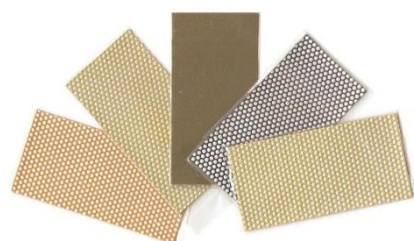

POLVERE DI DIAMANTATE

Utilizzabile per realizzare la propria sospensione di diamante mescolandola ad olio.

Confezione 10 Carati	Confezione 50 Carati	Micron μ	Mesh
DR-1280	DR-5280	0.5 (0-1)	#28.000
DR-1140	DR-5140	1 (0-2)	#14.000
DR-1080	DR-5080	3 (2-4)	#8.000
DR-1050	DR-5050	4.5 (3-6)	#5.000
DR-1030	DR-5030	6 (4-8)	#3.000
DR-1018	DR-5018	9 (6-12)	#1.800
DR-1012	DR-5012	15 (10-20)	#1.200
DR-1008	DR-5008	25 (20-30)	#800
DR-1006	DR-5006	35 (30-40)	#600
DR-1004	DR-5004	50 (40-60)	#400
DR-1002	DR-5002	90 (80-100)	#200



MOLETTE ROTATIVE CORINDONE BLU

Forma	Cod.	Testa $\varnothing \times L$	Gambo $\varnothing \times L$		Cod.	Testa $\varnothing \times L$	Gambo $\varnothing \times L$
	9376950	2x5	3x30		9376961	5x10	3x30
	9376951	3x6	3x30		9376966	13x13	3x30
	9376952	4x8	3x30				
	9376953	5x10	3x30				
	9376954	6x10	3x30				
	9376958	8x10	3x30				
	9376959	10x10	3x30				
	9376968	3x6	3x30		9376971	5x15	Gambo $\varnothing 6\text{mm}$
	9376962	5x10	3x30		9376972	11x25	Max 40.000g/min
	9376967	3x6	3x30		#60	#150	#280
	9376960	5x10	3x30		-	9376974	9376975
					9376976	9376977	9376978
	9376955	$\varnothing 3$	3x30				
	9376956	$\varnothing 5$	3x30				
	9376957	$\varnothing 8$	3x30				



												Superficie	Acc. da Utensili	Alluminio	NON Ferrosi	Inox	EDM	Metodo	Manuale	Limatrice	Ultrasuoni	Utilizzo	Umido	Secco	Sfaldamento	0=Lento 5=Veloce	Durezza	0=Tenera 5=Dura		
EDM																														
	AM-8	AO	Eccellente per ultrasuoni, resistente, mantiene la forma										•				▲		•	•	•			•				2	4	
			100	120	150	180	220	320	400	600	800	1000	1200																	
	AS-9	AO	La più utilizzata per EDM, ottima per limatrice o uso manuale										•				▲		•	•			•	•			3	3		
			100	120	150	180	220	280	320	400	600	800	1000	1200																
	Orange EDM	AO	Veloce azione di taglio, medio sfaldamento										•					•	•			•	•			3	3			
			120	180	220	320	400	600																						
	Golden Star	AO	Sfaldamento ottimale e ottima finitura										▲					▲		•	•			•			3	3		
			150	180	220	320	400	600	800	1000																				
Generali																														
	AM-2	AO	Utilizzo generale, tenera, sfaldamento veloce										▲	•	▲	•			•	•			•	•			4	2		
			100	150	180	220	320	400	600	900	1200																			
	DIE Stone	AO	Leggermente più dura di AM-2										•						•	•			•	•			3	3		
			150	180	220	320	400	600																						
	AM-K	AO	Ottima per fuperfici fresate										•	•					•	•			•	•			3	3		
			100	150	180	220	320	400	600																					
	AS-H	AO	Leggermente più tenera di AM-K										•	•	•	•			•	•			•	•			4	2		
			100	150	180	220	320	400	600	800	1000	1200																		
	CS	SC	Veloce azione di taglio e sfaldamento, tenera										•		•				•	•			•	•			5	2		
			150	180	220	320	400	600	800	1000	1200																			
	CS-M	SC	Veloce azione di taglio e sfaldamento, media										•	•	▲				•	•			•	•			4	2		
			120	180	220	320	400	600	800	1000	1200																			
	CS-HD	SC	Più dura di CS-M, eccellente per acciai temprati 47-63Hrc										•						•	•			•	•			3	3		
			120	150	220	320	400	600	800	1000	1200																			
Specializzate																														
	RASP	AO	Molto versatile, finitura, utilizzo universale										•	•	•	•	▲		•	•			•	•			4	2		
			80	100	150	220	320	400	600	900	1000																			
	PC	AO	Lucidatura finale										•	•	•	•			•	•			•				4	3		
			150	220	320	400	600	900	1200																					
	T2	AO	Eccellente per INOX										•				▲	•	•	•			•				2	4		
			150	220	320	400	600	800	1000	1200																				
	T4	AO	Per la finitura di alluminio e metalli teneri										•	▲	•	•			•	•			•				4	3		
			150	220	320	400	600	800	1000	1200																				
	TH	AO	Eccellente per tutti gli acciai da utensili										▲						•	•			•				3	3		
			150	220	320	400	600	800	1000	1200																				
	AO	AO	Aggressiva, pre-impregnata di lubrificante, per rimozione segni di fresatura e EDM										•						•	•			•				3	3		
			120	150	220	320	400	600	800	1000	1200																			
	900-F	AO	Extra morbida per superfinitura										•						•				•				5	0		
			900																											

▲ Pietra più indicata per l'applicazione

Dimensioni

pollici (mm)

1/2 x 1 (13 x 25)

1/2 x 1/2 (13 x 13)

3/8 x 3/8 (10 x 10)

1/4 x 1 (6 x 25)

1/4 x 1/2 (6 x 13)

1/4 x 1/4 (6 x 6)

1/2 (13)

3/8 (10)

1/4 (6)

1/8 x 1 (3 x 25)

1/8 x 1/2 (3 x 13)

1/8 x 1/4 (3 x 6)

5/32 x 5/32 (4 x 4)

1/8 x 1/8 (3 x 3)

1/16 x 1/4 (1.5 x 6)

1/16 x 1/2 (1.5 x 13)

1/2 (13)

3/8 (10)

1/4 (6)

SUPPORTI PORTAPIETRA



029910
Pietre
1/8x1/4, 1/4x1/4, 1/8x1/2



029912
Pietre
1/4x1/4, 1/4x1/2



029913
Pietre
1/16x1/4, 1/16x1/2



029914
Pietre
3/8, 1/4



029915
Set 029910, 029912
029913, 029914



029968
Gambo 1/8"
Pietre 1/4x1/2



029923
Gambo 3/16"



029924
Gambo 1/8"



029916
Gambo 3/16
Pietre 1/8x1/4



029917
Gambo 3/16
Pietre 1/8x1/2, 1/4x1/4



029918
Gambo 1/8
Pietre 1/8x1/4



029919
Gambo 1/8
Pietre 1/8x1/2, 1/4x1/4



029960
Gambo 3/16
Pietra 1/4 - Lungo



029963
Gambo 3/16
Pietra 1/4 - Corto



029967
Gambo 3/16
Pietra 1/8 - Corto



029958
Anello di ricambio
Grande



029950
Gambo 1/8
Per stick ceramici



029953
Gambo 3mm
Per stick ceramici



029954
Gambo 3/16
Per stick ceramici



029955
Anello di ricambio
Piccolo

LED E VISORI PER STAMPISTI

Luce led ad alta intensità

Cod.	Descrizione
380100	Rib-Light Led Blu
380110	Rib-Light Led Bianco
380130	Rib-Light Reach Led Bianco Parte Flessibile
380090	Batterie AAAA set 3pz



OptiVISOR				Cod. Lente Ricambio
Cod.	Tipo	Focale	Ingrandimento	
380150	DA-2	20"	1.50x	380151
380155	DA-3	14"	1.75x	380156
380160	DA-4	10"	2.00x	380161
380165	DA-5	8"	2.50x	380166
380170	DA-7	6"	2.75x	380171
380175	DA-10	4"	3.50x	380176
380140	Kit luce LED			
380180	KIT ingranditore monoculare 2.5x			

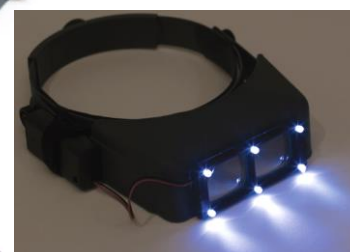

MOLETTE DIAMANTE SERIE BM

Gambo 3mm

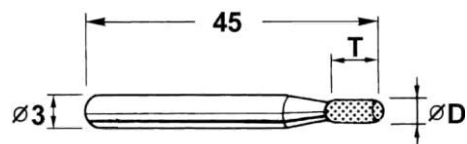

Ø D	1	1.5	2	2.5	3	3.5	4	5	6	1	1.5	2	2.5	3	3.5	4	5	6
T	8	8	8	8	10	10	10	10	10	8	8	8	8	10	10	10	10	10
Cod.	10A	15A	20A	25A	30A	35A	40A	50A	60A	10C	15C	20C	25C	30C	35C	40C	50C	60C
Grana	#150	#150	#120	#120	#120	#120	#120	#100	#100	#150	#150	#120	#120	#120	#120	#120	#100	#100

Ø D	2	3	3	1.2	1.5	1.5	2	3	2	3	4	5	6	2	3	4	5	6
T	10	10	10	16	13	10	12	14	12	15	15	15	13	10	10	10	10	12
Cod.	20T	30T	30V	13R	14R	15R	20R	30R	20P	30P	40P	50P	60P	20F	30F	40F	50F	60F
Grana	#120	#120	#120	#150	#150	#150	#150	#120	#150	#150	#150	#150	#150	#120	#120	#120	#100	#100

Ø D	3	4	5	6	1	1.5	2	2.5	3	4	5	6	8	3	4	5	6
T	14	9	10	13	-	-	-	-	-	-	-	-	-	5	7	9	10
Cod.	30J	40J	50J	60J	10B	15B	20B	25B	30B	40B	50B	60B	80B	30Q	40Q	50Q	60Q
Grana	#120	#120	#120	#100	#200	#150	#150	#120	#120	#120	#100	#100	#100	#120	#120	#100	#100

Ø D	2	3	4
T	4	6	8
Cod.	20S	30S	40S
Grana	#120	#120	#120



SET BMS-30



SET BMS-20

CBN: a richiesta min. 20pz per tipo

Serie BL Gambo 1/8" – 3.2mm a richiesta min. 20pz per tipo

Possibilità di esecuzione speciale a disegno, Q.tà min. 20 Pz.

SET BMS-30

(gambo 3mm) 30pz forme contrassegnate con * (BM-10A, 15A, 20A, 25A, 30A, 35A, 40A, 50A, 20B, 30B, 50B, 15C, 20C, 25C, 30C, 35C, 40C, 50C, 20P, 30P, 15R, 20R, 30R, 30S, 20F, 30F, 50F, 20T, 30T, 30V)

SET BLS-30 come set BMS-30 ma gambo 1/8" 3.2mm

SET BMS-20B

(gambo 3mm) 20pz (BM-10A, 15A, 20A, 25A, 30A, 35A, 15C, 20C, 25C, 30C, 20P, 30P, 15R, 20R, 30R, 20B, 30B, 20F, 30F, 20T)

SET BLS-20 come set BMS-20 ma gambo 1/8" 3.2mm

MOLETTE DIAMANTE SERIE BC

Gambo 6mm – L.tot. 60~65mm

CBN: a richiesta min. 20pz per tipo

Grane disponibili: #40, #60, #100 (da specificare)

Possibilità di esecuzione speciale a disegno, Q.tà min. 20 Pz



SET BC-10

Contiene 10pz forme contrassegnate con *
(specificare la grana)

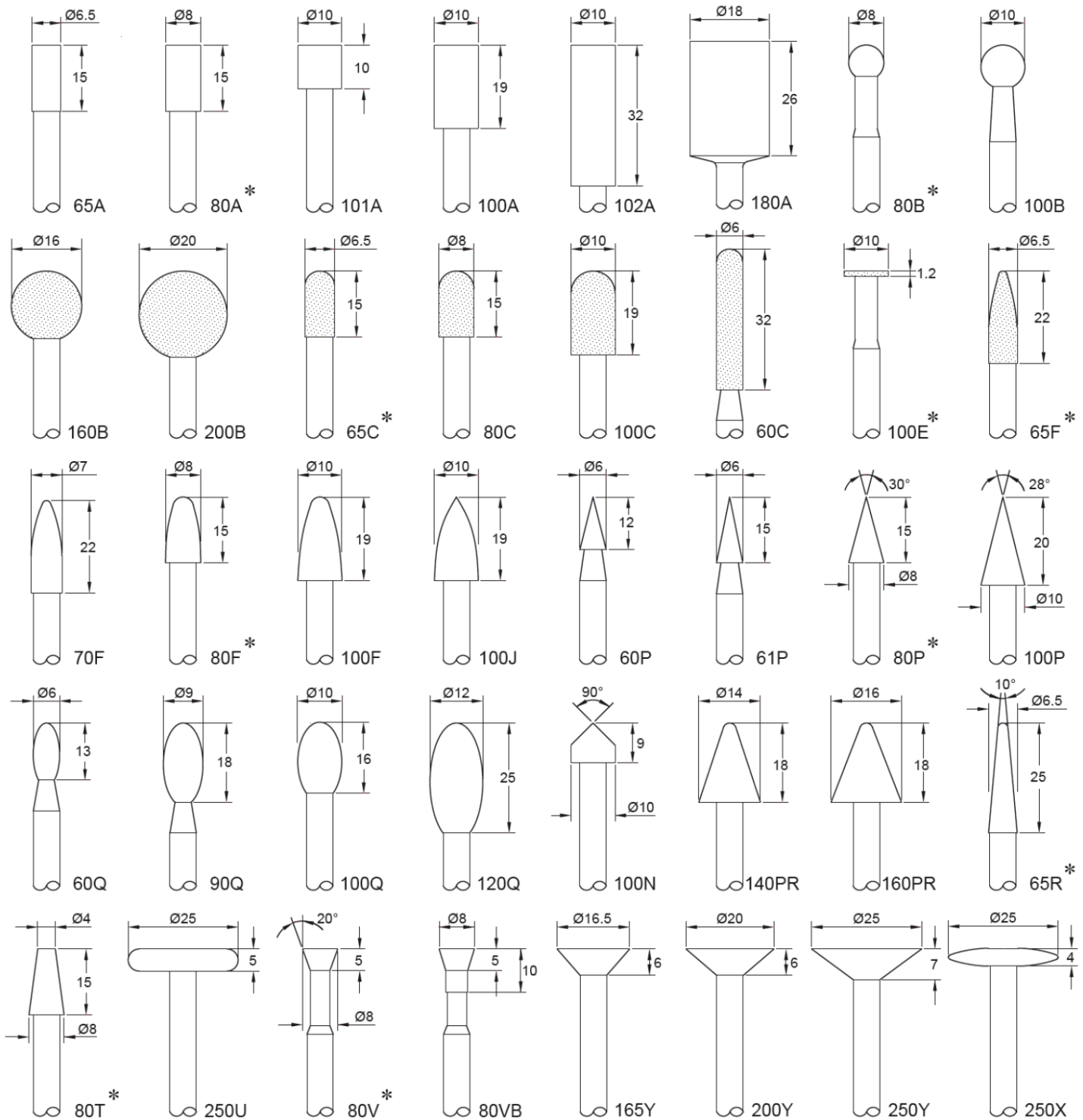

MOLETTE DIAMANTE SERIE BH

Gambo 2.34mm

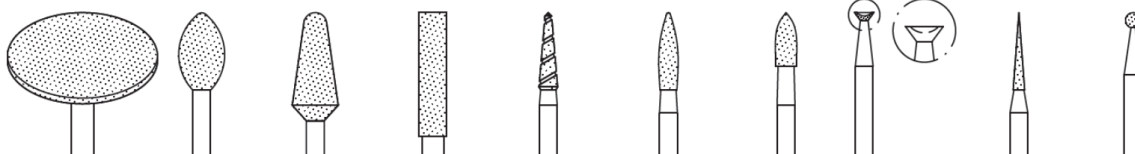
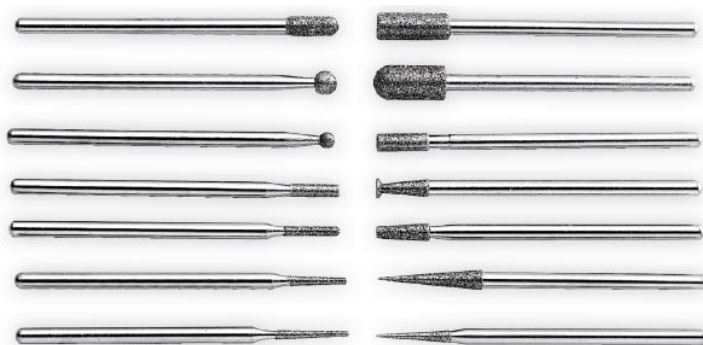
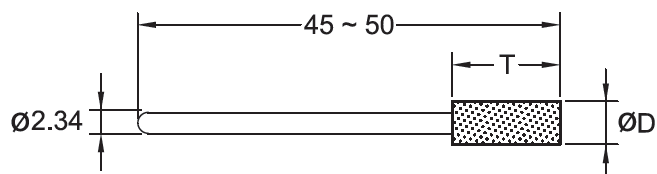

Ø D	16	6	6	3	2.5	2.5	2.5	3	1.5	2
T	0.5	10	14	15	10	10	6	45°	10	-
Cod.	BH160E	BH60Q	BH60R	BH30A	BH25K	BH25J	BH25F	BH30V	BH15P	BH20B
Grana	#200	#100	#100	#120	#150	#150	#120	#200	#200	#150

SET BHS-10: Contiene 10pz, uno per tipo delle forme sopra indicate

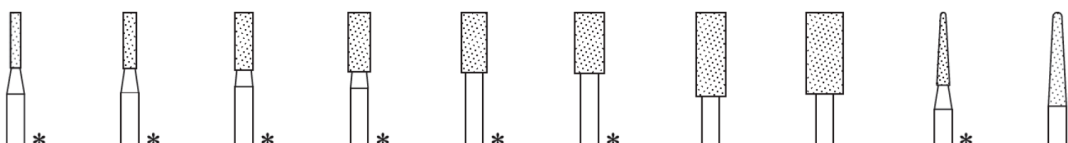

Ø D	1.1*	1.4*	1.9*	2.4*	2.7*	3.2*	3.9	4.9	1.4	2.4*
T	7	7	7	7	7	7	10	10	10	13
Cod.	BH11A	BH14A	BH19A	BH24A	BH27A	BH32A	BH39A	BH49A	BH14R	BH24R
Grana	#150	#150	#120	#120	#120	#120	#120	#120	#150	#150

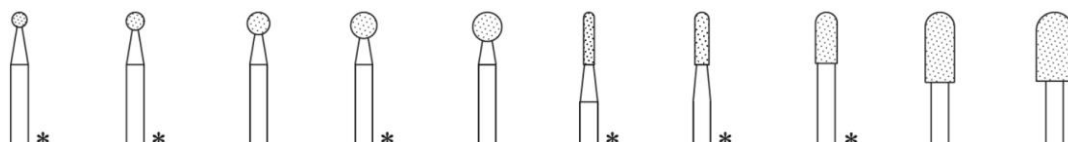

Ø D	2.0*	2.4*	3.0	3.5*	3.9	1.4*	1.9*	2.9*	3.9	4.9
T	7	7	7	7	7	7	10	10	10	13
Cod.	BH20B	BH24B	BH30B	BH35B	BH39B	BH14C	BH19C	BH29C	BH39C	BH49C
Grana	#150	#150	#120	#120	#120	#150	#120	#120	#150	#120

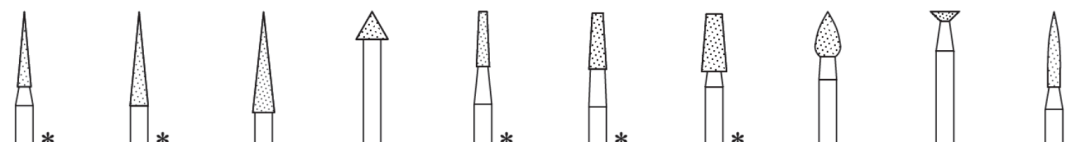

Ø D	1.8*	2.4*	2.9	4.2	1.4*	1.9*	2.6*	3	3	1.7*
T	10	12	14	6	7	7	7	6	-	10
Cod.	BH18P	BH24P	BH29P	BH42P	BH14T	BH19T	BH26T	BH30S	BH30Y	BH17J
Grana	#150	#150	#150	#150	#120	#120	#120	#120	#150	#150

Ordine minimo 10pz

SET BHS-30: Contiene 30pz, uno per tipo delle forme sopra indicate

SET BHS-20: Contiene 20pz, uno per tipo delle forme sopra contrassegnate con *

MOLETTE DIAMANTE SERIE BH

Gambo 2.34mm

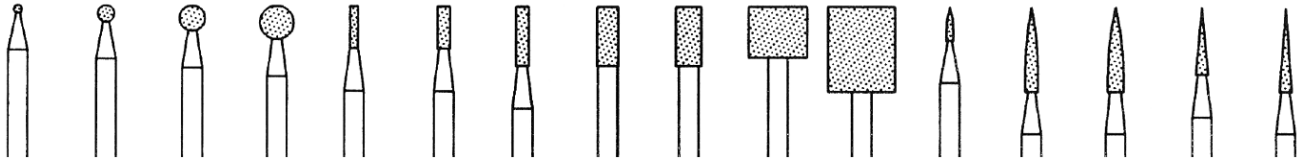
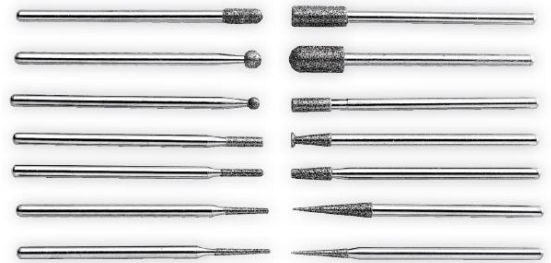
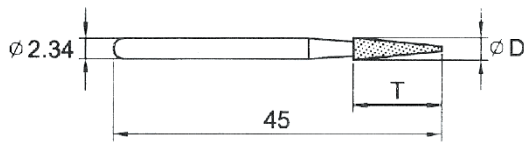

Ø D	1	2	3	4	1	1.5	1.5	2.5	3	7	8	0.9	1.5	2	1.5	1.5
T	-	-	-	-	5	5	7	7	7	6	10	4	10	10	8	10
Cod.	D1	D2	D3	D4	A11	A12	A13	A21	A30	7A	8A	C3	C13	C23	TR	1R

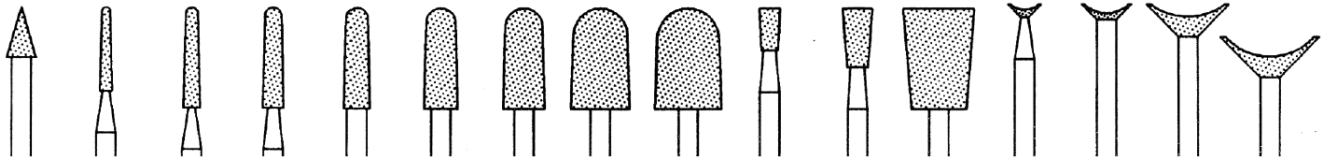

Ø D	3.5	1.5	2	2.5	3	4	5	7	8	2	2.5	7	4	6	10	12
T	6	10	12	12	12	12	12	12	12	5	7	12	-	-	-	-
Cod.	KS	1LR	2R	2LR	3R	5R	6R	7R	8R	K6	K10	KA	12BA	14BA	16BA	19BA

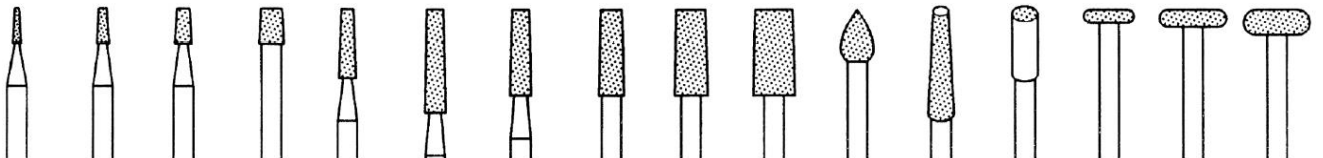

Ø D	1	1.5	2	3	2	2.5	2.5	3	4	5	4	2.5	2.5	6	8	8
T	4	4	4	4	8	12	10	10	10	10	6	12	7	1.5	2	3
Cod.	T11	T12	T13	T30	1A	2A	2LA	3A	5A	6A	RZ	2LB	A14	Kr5	Kr8	Kr9

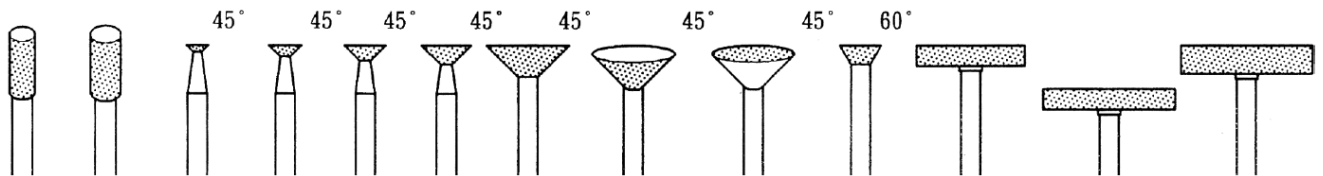

Ø D	2.5	3	2.7	4	5	6	10	10	10	5	13	16	16
T	7	7	-	-	-	-	-	-	-	-	2.5	2.5	3.5
Cod.	A20	A31	10B	12B	13B	14B	16B	16BB	16BC	13nk	13mB	16mC	16mB

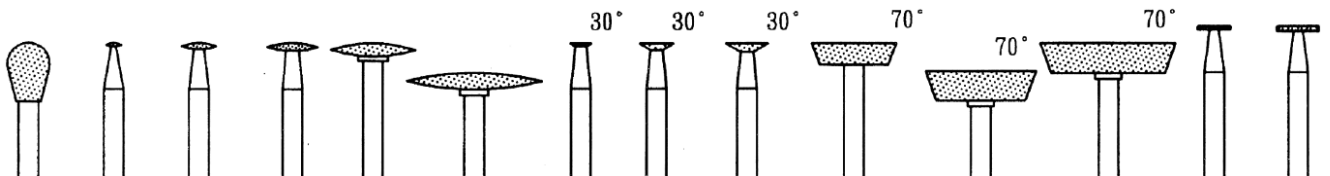

Ø D	5	1.8	4	6	10	16	2.5	4	5	10	13	16	4	5
T	7	0.5	0.8	1	1.6	2	-	-	-	2.5	3.5	3.5	0.4	0.6
Cod.	RT	10X	17X	18X	19X	23X	10BN	12BN	13BN	10mA	13mA	16mA	K25	K30

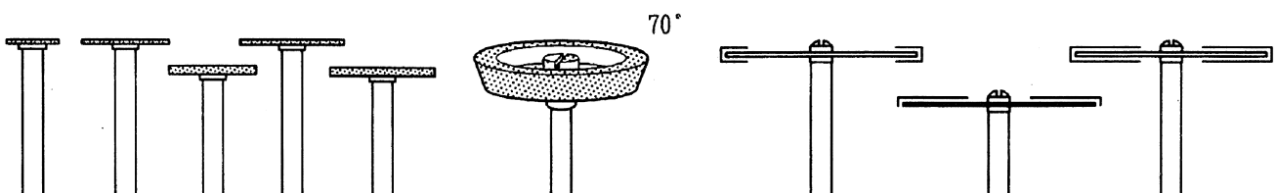

Ø D	6	10	10	12	12	20	22	22	22
T	0.5	0.5	1	0.6	1	3.5	0.45	0.35	0.45
Cod.	K35	K45	K50	K55	K60	20mA	88D	88C	88A

Ordine minimo 20pz

MOLETTE DIAMANTE CONICHE

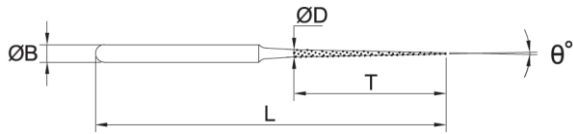

	ØD	T	θ°	ØB	L	Grana	Cod.		ØD	T	θ°	ØB	L	Grana	Cod.
	1.8	25	3.1	3.0	50	#150	18PL		6.0	33	10	6.0	60	#150	60P10
	2.1	34	2.8	3.0	55	#150	21PXL		6.0	28	12	6.0	60	#150	60P12
	3.0	25	6.4	3.0	60	#150	30PL		6.0	23	14	6.0	60	#150	60P14
	4.8	26	9.6	3.0	55	#150	48PL		6.0	21	16	6.0	60	#150	60P16
	1.5	26	2.3	3.0	60	#150	15PL		6.0	17	20	6.0	60	#150	60P20
	2.0	48	1.9	3.0	70	#150	20PXL		10.0	19	30	6.0	60	#150	100P30
	2.3	40	2.7	3.0	65	#150	23PXL								
	2.5	45	2.6	3.0	70	#150	25PXL								
	3.0	38	4.2	3.0	70	#150	30PXL								

Ordine minimo 10pz

DISCHETTI DIAMANTE

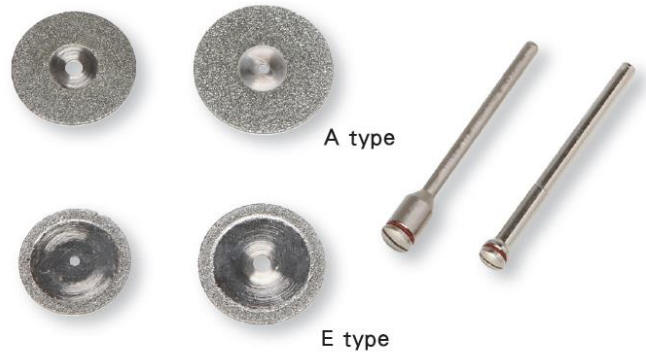
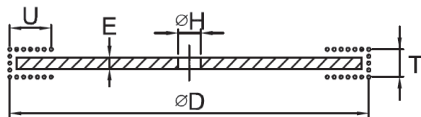

Cod.	Tipo	ØD	T	U	E	ØH	Grana	Alberino
BM-190E	E	19	0.4	2	0.2	1.0	#200	A - B - C
BM-190A	A	19	0.4	6	0.2	1.0	#200	A - B - C
BM-220E	E	22	0.4	2	0.2	1.0	#200	A - B - C
BM-220A	A	22	0.4	8	0.2	1.0	#200	A - B - C
BM-250E	E	25	0.4	2	0.2	1.0	#200	A - B - C
BM-250A	A	25	0.5	8	0.2	1.0	#150	A - B - C
BM-300E	E	30	0.4	2	0.2	1.0	#200	A - B - C
BM-300A	A	30	0.5	8	0.2	1.0	#200	A - B - C
BM-221E	E	22	0.4	2	0.2	3.0	#200	D - E - F
BM-221A	A	22	0.4	8	0.2	3.0	#200	D - E - F
BM-251E	E	25	0.4	2	0.2	3.0	#200	D - E - F
BM-251A	A	25	0.5	8	0.2	3.0	#150	D - E - F
BM-301E	E	30	0.4	2	0.2	3.0	#200	D - E - F
BM-301A	A	30	0.5	10	0.2	3.0	#150	D - E - F

Ordine minimo 10pz

Tipo	Cod.	ØD	Ød	Tipo	Cod.	ØD	Ød
A	AK234	2.34	1.7	D	MK234	2.34	3.0
B	AK300	3.0	1.7	E	MK300	3.0	3.0
C	AK318	3.175	1.7	F	MK318	3.175	3.0

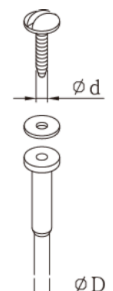

PUNTE DIAMANTATE

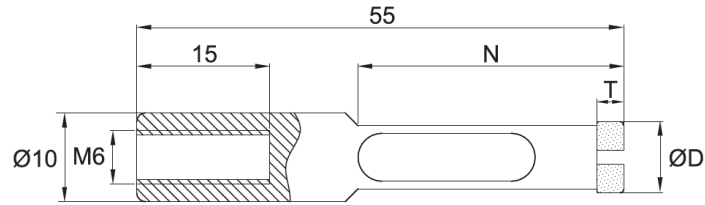

Cod.	ØD		T	N	Grana
	mm	pollici			
ESD-032	3.2	1/8	10	25	#60
ECD-050	5.0	3/16	3	30	#60
ECD-065	6.5	1/4	3	30	#60
ECD-080	8	5/16	3	30	#60
ECD-100	10	3/8	3	30	#60
ECD-130	13	1/2	3	30	#60
ECD-160	16	5/8	3	35	#60
ECD-191	19.05	3/4	3	35	#60
ECD-254	25.4	1	3	35	#60

Altre grane fornibili a richiesta

DISCHI DA TAGLIO DIAMANTATI

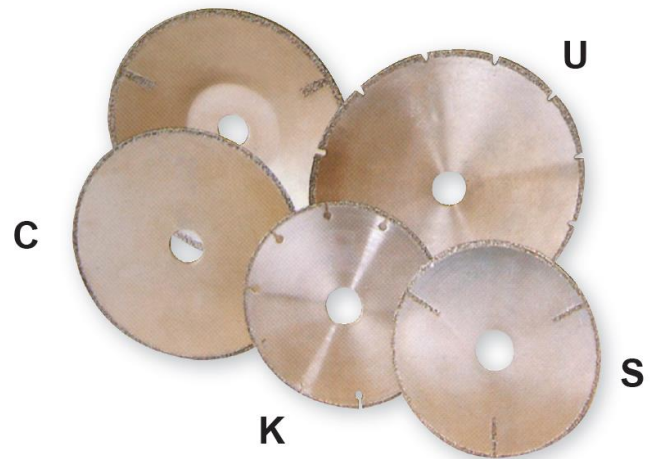
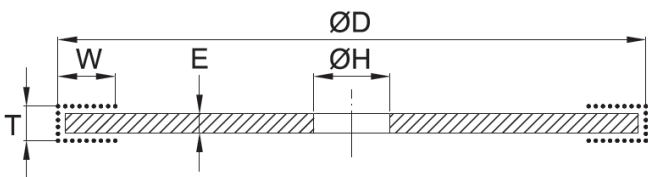

Cod.	ØD	E	T	W	Tipo	ØH	Grana
SP-05008	50	0.8	1.8	2~3	C-S-U	A richiesta	#40
SP-06308	63	0.8	1.8	2~3	C-S-U		#40
SP-10008	100	0.8	1.8	2~3	C-S-U		#40
SP-11508	115	0.8	1.8	2~3	C-S-U		#40
SP-11510K	115	1.0	2.0	2~3	K		#40
SP-12508	125	0.8	1.8	2~3	C-S-U		#40
SP-15008	150	0.8	1.8	2~3	C-S-U		#40
SP-15012	150	1.2	2.2	2~3	C-S-U		#40
SP-17512	175	1.2	2.2	2~3	C-S-U		#40
SP-20012	200	1.2	2.2	2~3	C-S-U		#40
SP-15012	250	1.2	2.2	2~3	C-S-U		#40
SP-30012	300	1.2	2.2	2~3	C-S-U		#40

Altre grane fornibili a richiesta

RETTIFICA INTERNI

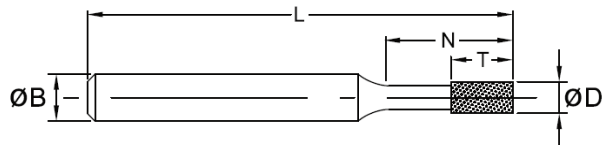

Type A

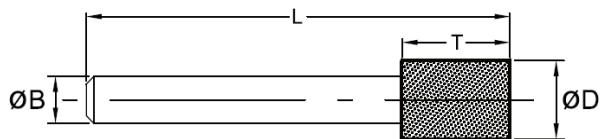

Type B



Diamante	CBN	Tipo	Ø D	T	N	L	Ø B	Grana	Diamante	CBN	Tipo	Ø D	T	N	L	Ø B	Grana
ID-3003	IB-3003	A	0.3	2	4	35	3	#600	ID-6040	IB-6040	A	4	10	22	80	6	#100
ID-3004	IB-3004	A	0.4	2	5	35	3	#400	ID-6050	IB-6050	A	5	10	22	80	6	#100
ID-3005	IB-3005	A	0.5	2	8	45	3	#400	ID-6060	IB-6060	A	6	10	-	80	6	#100
ID-3006	IB-3006	A	0.6	3	8	45	3	#200	ID-6070	IB-6070	B	7	10	-	80	6	#100
ID-3007	IB-3007	A	0.7	3	8	45	3	#200	ID-6080	IB-6080	B	8	10	-	80	6	#100
ID-3008	IB-3008	A	0.8	3	8	45	3	#200	ID-6090	IB-6090	B	9	10	-	80	6	#100
ID-3009	IB-3009	A	0.9	4	8	45	3	#200	ID-6100	IB-6100	B	10	10	-	80	6	#100
ID-3010	IB-3010	A	1	5	8	45	3	#200	ID-6120	IB-6120	B	12	10	-	80	6	#100
ID-3015	IB-3015	A	1.5	5	8	45	3	#150	ID-6140	IB-6140	B	14	10	-	80	6	#100
ID-3020	IB-3020	A	2	5	12	45	3	#150	ID-6160	IB-6160	B	16	10	-	80	6	#100
ID-3025	IB-3025	A	2.5	5	15	45	3	#150	ID-6180	IB-6180	B	18	10	-	80	6	#100
ID-3030	IB-3030	A	3	5	15	45	3	#150									
ID-3040	IB-3040	B	4	5	-	50	3	#150									
ID-3050	IB-3050	B	5	8	-	50	3	#150									
ID-3060	IB-3060	B	6	8	-	50	3	#150									

Ordine minimo 3pz. Possibilità di esecuzione speciale a disegno o altre grane, Q.tà min. 20 Pz.

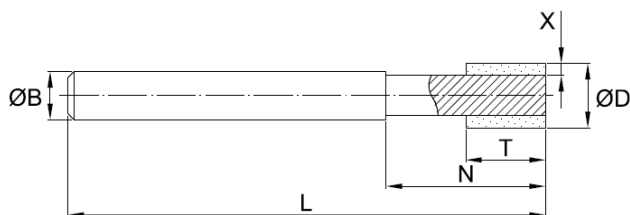

Type A

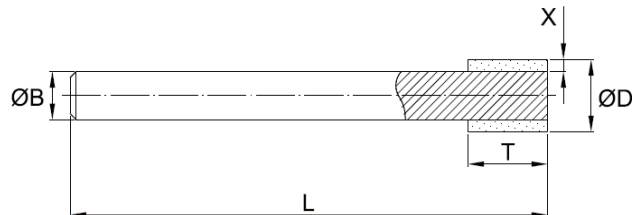

Type B



CBN Vetrificate	Tipo	Ø D	T	X	N	L	Ø B	Grana	CBN Resinoidi	Tipo	Ø D	T	X	N	L	Ø B	Grana
VIB-3040	A	4	6	1.0	12	60	3	#200	RIB-3040	A	4	5	1.0	12	45	3	#200
VIB-3050	A	5	6	1.5	12	60	3	#200	RIB-3045	A	4.5	6	1.25	12	45	3	#200
VIB-3060	A	6	6	2.0	12	60	3	#200	RIB-3050	A	5	6	1.5	12	45	3	#200
VIB-3080	A	8	8	3.0	12	60	3	#200	RIB-6060	A	6	6	2.0	15	80	6	#150
VIB-6100	B	10	8	2.0	-	80	6	#200	RIB-6070	A	7	8	2.5	15	80	6	#150
VIB-6120	B	12	10	3.0	-	80	6	#200	RIB-6080	A	8	8	3.0	20	80	6	#150
VIB-8140	B	14	12	3.0	-	80	8	#200	RIB-6100	A	10	10	2.0	20	80	6	#150
VIB-6140	B	14	12	4.0	-	80	6	#200	RIB-6120	B	12	10	3.0	-	80	6	#150
VIB-8160	B	16	12	4.0	-	80	8	#200	RIB-6140	B	14	10	4.0	-	80	6	#150
VIB-6160	B	16	12	5.0	-	80	6	#200	RIB-6160	B	16	10	4.0	-	80	6	#150
VIB-8180	B	18	12	5.0	-	80	8	#200	RIB-6180	B	18	10	5.0	-	80	6	#150
VIB-6180	B	18	12	6.0	-	80	6	#200	RIB-6200	B	20	10	6.0	-	80	6	#150

Ordine minimo 3pz. Altre grane fornibili a richiesta, Q.tà min. 20 Pz.

LIME DIAMANTATE

PF-10

140Lx50TxØ3.0B

Grana: #120 (a richiesta #200, #400)

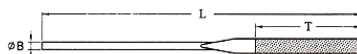

Forma - Dimensioni		#120	#200	#400
1		5.5x1.5	PF-101	PF-101F PF-101V
2		5x2	PF-102	PF-102F PF-102V
3		Ø 3	PF-103	PF-103F PF-103V
4		2.5	PF-104	PF-104F PF-104V
5		3.5	PF-105	PF-105F PF-105V
SET 5 Pz		PF-100	PF-100F	PF-100V



PF-10L

140Lx70TxØ3.0B

Grana: #120 (a richiesta #200, #400)

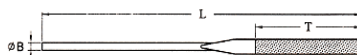

Forma - Dimensioni		#120	#200	#400
1		5.5x1.5	PF-101L	PF-101LF PF-101LV
2		5x2	PF-102L	PF-102LF PF-102LV
3		Ø 3	PF-103L	PF-103LF PF-103LV
4		2.5	PF-104L	PF-104LF PF-104LV
5		3.5	PF-105L	PF-105LF PF-105LV
6		5.4X1.5	PF-106L	PF-106LF PF-106LV
7		1.7X6	PF-107L	PF-107LF PF-107LV
8		6X2	PF-108L	PF-108LF PF-108LV
9		5X2	PF-109L	PF-109LF PF-109LV
10		6X1.5	PF-110L	PF-110LF PF-110LV
SET 10 Pz		PF-100L	PF-100LF	PF-100LV



PF-70

140Lx40~50TxØ3.0B

Grana: #150 (a richiesta #200, #400)

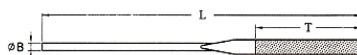

Forma - Dimensioni		#150	#200	#400
1		5.5x0.5	PF-705	PF-705F PF-705V
2		5.5x0.8	PF-708	PF-708F PF-708V
3		5.5x1.0	PF-710	PF-710F PF-710V



PFL-10

180Lx25~50TxØ3.0B (con impugnatura PVC)

Grana: #120 (a richiesta #200, #400)

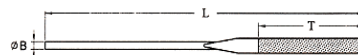

Forma - Dimensioni		#120	#200	#400
1		5.5x1.5	PFL-101	PFL-101J PFL-101V
2		5x2	PFL-102	PFL-102J PFL-102V
3		Ø 3	PFL-103	PFL-103J PFL-103V
4		2.5	PFL-104	PFL-104J PFL-104V
5		3.5	PFL-105	PFL-105J PFL-105V
6		5.5X1	PFL-106	PFL-106J PFL-106V
7		5.5X0.5	PFL-107	PFL-107J PFL-107V
8		5.5X0.8	PFL-108	PFL-108J PFL-108V
9		2	PFL-109	PFL-109J PFL-109V
10		5.5X1.5	PFL-110	PFL-110J PFL-110V
SET 10 Pz		PFL-100	PFL-100J	PFL-100V



PF-20

200Lx70TxØ4.0B

Grana: #120 (a richiesta #200, #400)

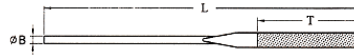

Forma - Dimensioni		#120	#200	#400
1	8.5x1.6	PF-201	PF-201F	PF-201V
2	7x2.5	PF-202	PF-202F	PF-202V
3	Ø 4	PF-203	PF-203F	PF-203V
4	3.5	PF-204	PF-204F	PF-204V
5	4.5	PF-205	PF-205F	PF-205V
SET 5 Pz		PF-200	PF-200F	PF-200V



PF-30

180Lx60TxØ3.4B

Grana: #120 (a richiesta #200, #400)

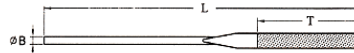

Forma - Dimensioni		#120	#200	#400
1	7.5x1.5	PF-301	PF-301F	PF-301V
2	6x2.1	PF-302	PF-302F	PF-302V
3	Ø 3.5	PF-303	PF-303F	PF-303V
4	3	PF-304	PF-304F	PF-304V
5	4	PF-305	PF-305F	PF-305V
SET 5 Pz		PF-300	PF-300F	PF-300V



BF-60

140Lx30TxØ3B

Grana: #150 (a richiesta #200, #400)

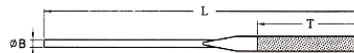

Forma - Dimensioni		#150	#200	#400
1	6x1.3	BF-601	BF-601F	BF-601V
2	5x2	BF-602	BF-602F	BF-602V
3	Ø 3	BF-603	BF-603F	BF-603V
4	2.5	BF-604	BF-604F	BF-604V
5	3.5	BF-605	BF-605F	BF-605V
SET 5 Pz		BF-600	BF-600F	BF-600V

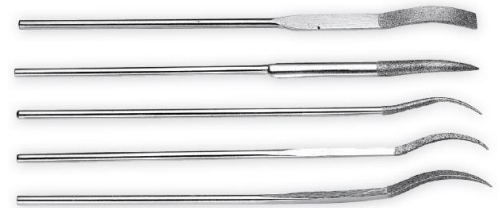

BF-80

155Lx20~30TxØ3B

Grana: #200 (a richiesta #150, #400)

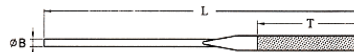

Forma - Dimensioni		#200	#150	#400
1	3x2	BF-801	BF-801F	BF-801V
2	Ø 2	BF-802	BF-802F	BF-802V
3	Ø 3	BF-803	BF-803F	BF-803V
4	Ø 3	BF-804	BF-804F	BF-804V
5	3	BF-805	BF-805F	BF-805V
6	3	BF-806	BF-806F	BF-806V
SET 6 Pz		BF-800	BF-800F	BF-800V



BF-90

140Lx20TxØ3B

Grana: #200 (a richiesta #150, #400)

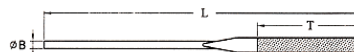

Forma - Dimensioni		#200	#150	#400
1	6x1.3	BF-901	BF-901F	BF-901V
2	2.5	BF-902	BF-902F	BF-902V
3	3.5x1.5	BF-903	BF-903F	BF-903V
4	3.5	BF-904	BF-904F	BF-904V
5	5x2	BF-905	BF-905F	BF-905V
6	3.5x1.5	BF-906	BF-906F	BF-906V
7	3.5x2	BF-907	BF-907F	BF-907V
8	Ø 3	BF-908	BF-908F	BF-908V
9	5x1.5	BF-909	BF-909F	BF-909V
10	Ø 2.3	BF-910	BF-910F	BF-910V
SET 10 Pz		BF-900	BF-900F	BF-900V



PTF	L	T	Sezione	Grana	Cod.
	130	30		#200	PTF-12F
				#400	PTF-12V
				#600	PTF-12X
	130	30		#200	PTF-14F
				#400	PTF-14V
				#600	PTF-14X
	130	30		#200	PTF-16F
				#400	PTF-16V
				#600	PTF-16X
	140	50		#600	PF-103



PTF-100 Set 10 Pz

CF	T	Sezione	Grana	Cod.
	40		#600	CF-402J
			#200	CF-402F
			#400	CF-402V
	50		#600	CF-404J
			#200	CF-404F
			#400	CF-404V
	50		#600	CF-406J
			#200	CF-406F
			#400	CF-406V
	50		#600	CF-408J
			#200	CF-408F
			#400	CF-408V



CF-400 Set 10 Pz

IF-50	Grana: #100	L	T	Sezione	Cod.
		215	80		IF-501
		215	80		IF-502
		215	80		IF-503
		215	80		IF-504
		215	80		IF-505

CF-50	Grana: #150, #200	L	T	Sezione	Cod.
		180	70		CF-501
		180	60		CF-502
		180	60		CF-503
		180	50		CF-504
		180	50		CF-505

CF500 : Set 5pz

LIME DIAMANTATE SINTERIZZATE	L	T	Sezione	Grana	Cod.
	72	20		#200	MMF-615F
				#400	MMF-615V
				#600	MMF-615X
	54	20		#200	MDT-02F
				#400	MDT-02V
				#600	MDT-02X
	105	20		#200	MDT-03F
				#400	MDT-03V
				#600	MDT-03X

LIME DIAMANTATE serie FA

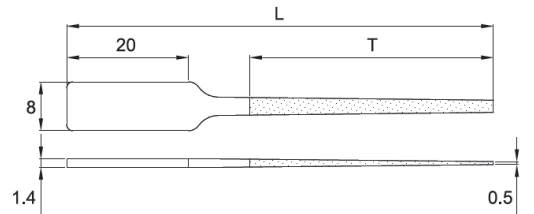
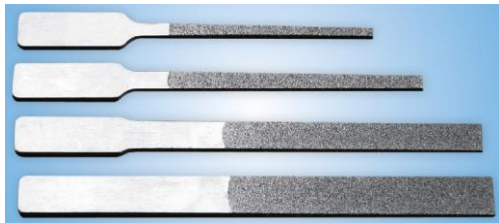

	70	40		#150 #200 #400 #600	FA-632J FA-632F* FA-632V* FA-632X*
	80	50		#150 #200 #400 #600	FA-643J* FA-643F* FA-643V* FA-643X*
	90	50		#150 #200 #400 #600	FA-666J* FA-666F* FA-666V FA-666X
	90	50		#150 #200 #400 #600	FA-688J* FA-688F* FA-688V FA-688X
		122			XH-32

FAS-600 : Set XH-32 + 10pz uno per tipo delle forme sopra contrassegnate con *

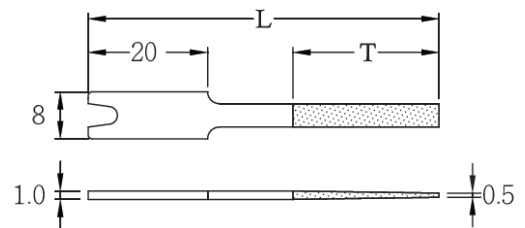
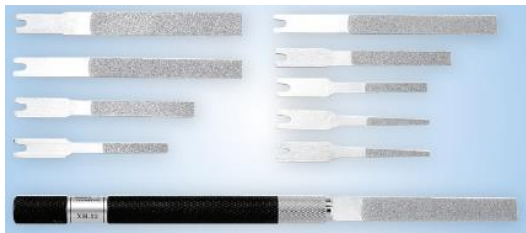

	L	T	Sezione	Grana	Cod.
	60	25		#150 #200 #400	FA-426J* FA-426F* FA-426V
	60	25		#150 #200 #400	FA-446J* FA-446F* FA-446V
	70	40		#150 #200 #400	FA-667J* FA-667F* FA-667V
	70	40		#150 #200 #400	FA-887J FA-887F FA-887V
	90	60		#150 #200 #400	FA-889J* FA-889F* FA-889V
	70	40		#150 #200 #400	FA-107J FA-107F FA-107V
	90	60		#150 #200 #400	FA-109J* FA-109F* FA-109V
	60	25		#200 #400 #600	FA-326F FA-326V FA-326X
	60	25		#200 #400 #600	FA-436F FA-436V FA-436X
	70	40		#200 #400 #600	FA-327F FA-327V FA-327X
	70	40		#200 #400 #600	FA-437F FA-437V FA-437X
		122			XH-12

FAS-100T : Set XH-12 + 10pz uno per tipo delle forme sopra contrassegnate con *

PF-10

90Lx45TxØ3.0B

Grana: #150 (a richiesta #200, #400)

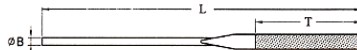

Forma - Dimensioni			#150	#200	#400
1		5.5x1.5	MPF-101	MPF-101F	MPF-101V
2		5x2	MPF-102	MPF-102F	MPF-102V
3		Ø 3	MPF-103	MPF-103F	MPF-103V
4		2.5	MPF-104	MPF-104F	MPF-104V
5		5x2	MPF-105	MPF-105F	MPF-105V
SET 5 Pz			MPF-100	MPF-100F	MPF-100V



MBF-60

85Lx30TxØ3.0B

Grana: #150 (a richiesta #200, #400)

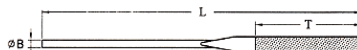

Forma - Dimensioni			#150	#200	#400
1		5.5x1.5	MBF-601	PF-101F	PF-101V
2		5x2	MBF-602	PF-102F	PF-102V
3		Ø 3	MBF-603	PF-103F	PF-103V
4		2.5	MBF-604	PF-104F	PF-104V
5		3.5	MBF-605	PF-105F	PF-105V
SET 5 Pz			MBF-600	MBF-600F	MBF-600V



BF-90

65Lx20~30TxØ3B

Grana: #200 (a richiesta #200, #400)

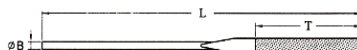

Forma - Dimensioni			#150	#200	#400
1		5.8x1.2	MBF-901	MBF-901F	MBF-901V
2		3.2x1.4	MBF-902	MBF-902F	MBF-902V
3		5x2	MBF-903	MBF-903F	MBF-903V
4		3.2x1.4	MBF-904	MBF-904F	MBF-904V
5		Ø 3	MBF-905	MBF-905F	MBF-905V
6		Ø 3	MBF-906	MBF-906F	MBF-906V
7		2.5	MBF-907	MBF-907F	MBF-907V
8		3.2x1.4	MBF-908	MBF-908F	MBF-908V
9		3.2x1.4	MBF-909	MBF-909F	MBF-909V
10		3.5x2	MBF-910	MBF-910F	MBF-910V
SET 10 Pz			MBF-900	MBF-900F	MBF-900V



MTP

	L	T	Sezione	Grana	Cod.
	70	25		#600	MTP-12J
				#200	MTP-12F
				#300	MTP-12H
				#400	MTP-12V
	70	25		#600	MTP-14J
				#200	MTP-14F
				#300	MTP-14H
				#400	MTP-14V
	70	25		#600	MTP-16J
				#200	MTP-16F
				#300	MTP-16H
				#400	MTP-16V



MTP-120 Set 10 Pz

MTF

	L	T	Sezione	Grana	Cod.
	72	15		#200	MTF-13F
				#400	MTF-13V
				#600	MTF-13X
	72	15		#200	MTF-16F
				#400	MTF-16V
				#600	MTF-16X
	56	15		#200	MTF-23F
				#400	MTF-23V
				#600	MTF-23X
	56	15		#200	MTF-26F
				#400	MTF-26V
				#600	MTF-26X



MTF-100 Set 10 Pz

UTENSILI PNEUMATICI SERIE ECO (TAIWAN)

SMERIGLIATRICI PNEUMATICHE



UG-500 - 60.000 g/min

Pinza: Ø 3mm (2.34mm a richiesta)

Dimensioni: Ø 20x160L mm - Peso: 110 gr.



UG-300 - 35.000 g/min

Doppia Pinza: Ø 3 & 6mm (3.2 & 6.35mm a richiesta)

Dimensioni: Ø 22x180L mm - Peso: 170 gr.

LIMATRICI PNEUMATICHE A CORSA LUNGA

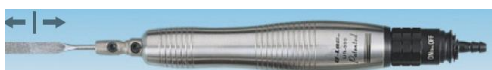

Corsa lunga per ampie superfici.

UR-120 - 12.000 colpi/min

Corsa: 1.2 mm

Dimensioni: Ø 18x180L mm - Peso: 250 gr.

UR-300 - 10.000 colpi/min

Corsa: 3.0 mm

Dimensioni: Ø 18x180L mm - Peso: 250 gr.

LIMATRICI PNEUMATICHE A CORSA CORTA



UTR-20 - 35.000 colpi/min

Corsa: 0.15 mm

Dimensioni: Ø 28x200L mm - Peso: 190 gr.

Motore a turbina - SENZA lubrificazione



UTR-30 - 30.000 colpi/min

Corsa: 0.3 mm

Dimensioni: Ø 28x200L mm - Peso: 190 gr.

Motore a turbina - SENZA lubrificazione



UTR-70 - 28.000 colpi/min

Corsa: 0.7 mm

Dimensioni: Ø 28x200L mm - Peso: 190 gr.

Motore a turbina - SENZA lubrificazione

LIMATRICI PNEUMATICHE A CORSA LATERALE

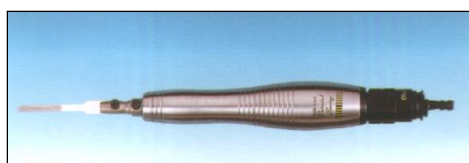

Corsa Laterale

Per lavorazione di scanalature o gole.

US-70 - 15.000 colpi/min

Corsa: 0.7 mm

Dimensioni: Ø 28x205L mm - Peso: 305 gr.

US-100 - 11.000 colpi/min

Corsa: 1.0 mm

Dimensioni: Ø 28x205L mm - Peso: 305 gr.

LIMATRICI PNEUMATICHE PER UTILIZZO GRAVOSO

Modello	AF-5	AF-10
Valvola	Leva	Leva
Dimensioni Lunghezza	163mm	210mm
Sezione	29x29mm	39x37mm
Scarico Aria	Posteriore	Posteriore
Velocità (colpi/min)	3.400	5.500
Corsa (mm)	5	10
Consumo Aria (l/min)	200	280
Peso (gr)	400	900
Pinza	Vite Serraggio	Vite Serraggio
Tubo Aria	Incluso	Incluso



LIMATRICI PNEUMATICHE TURBOLAP (JAPAN)



TLL-30 - 52.000 RPM

Corsa: 0.3 mm LINEARE

Dimensioni: Ø 28x218L mm - Peso: 180 gr.

Motore a turbina - SENZA lubrificazione



TLL-70 - 28.000 RPM

Corsa: 0.7 mm LINEARE

Dimensioni: Ø 28x218L mm - Peso: 180 gr.

Motore a turbina - SENZA lubrificazione



TLS-12 - 14.000 RPM

Corsa: 3mm LATERALE + 1.2mm LINEARE

Dimensioni: Ø 28x218L mm - Peso: 180 gr.

Motore a turbina - SENZA lubrificazione



SMERIGLIATRICE PNEUMATICA ANGOLARE (JAPAN)



IR-310

Testina pinza 3mm (92gr)



IC-300

Testina angolare 90° pinza 3mm (45gr)



IM-301

Motore pneumatico 30.000rpm 46W 130gr
Aria Lubrificata

MANNESMANN DEMAG

Utensili pneumatici

Smerigliatrici, Limatrici, Svasatori, Trapani, Maschiatori, Avvitatori



Made in Germany

MANNESMANN DEMAG

Mandrini Pneumatici – Mandrini Robotici



Made in Germany

LIME ROTATIVE IN METALLO DURO



MADE IN USA

PRODOTTI ABRASIVI IN FIBRA

Sbavatura e finitura in una passata, particolarmente indicati per Titanio, Inox, Alluminio, Leghe, Metalli esotici

